

CRACKERJACK BOX

● x 120-150
● x 4

Average time:
55-60 seconds

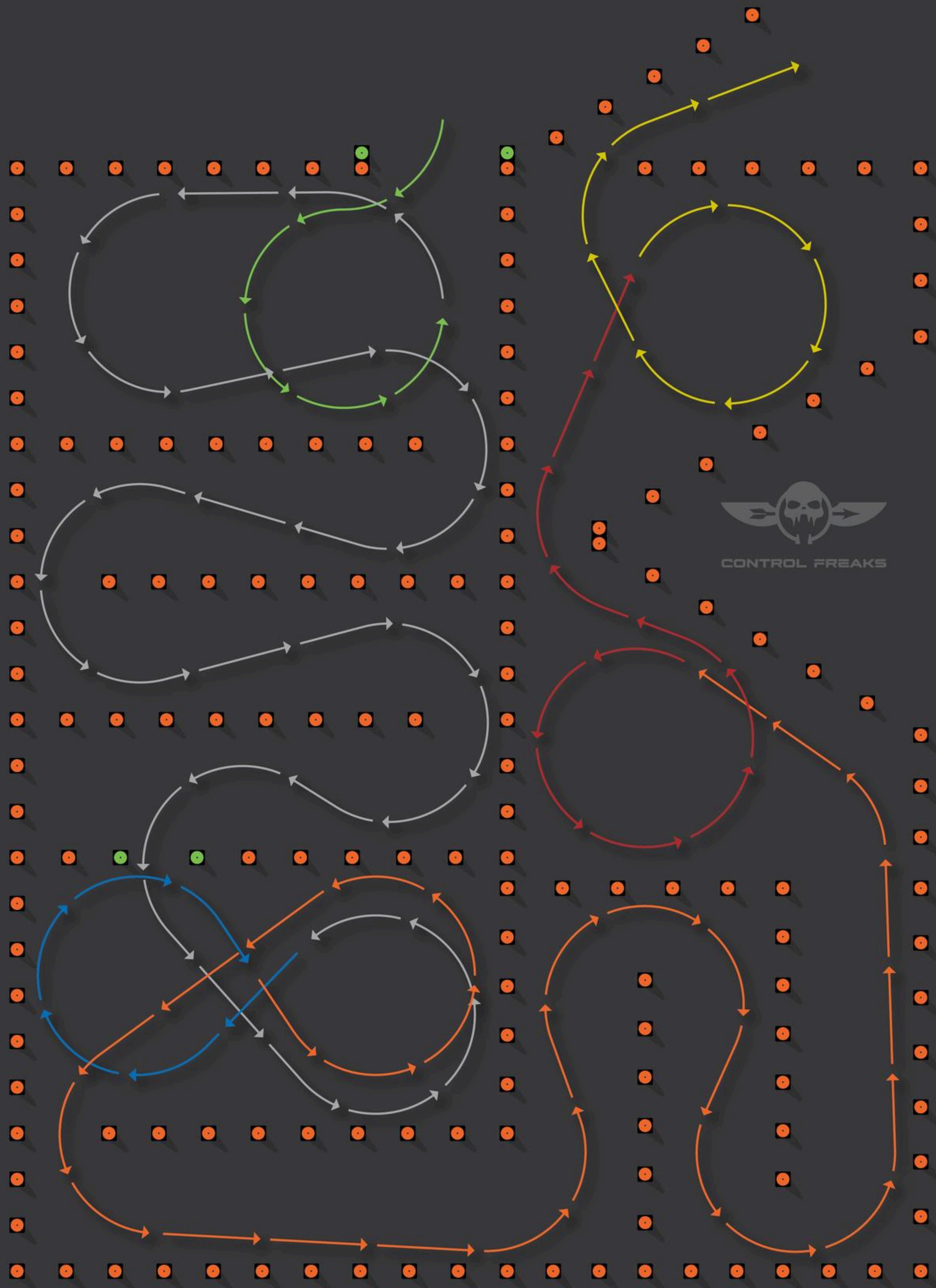

CAJUN CRAZE^T

● x 65 - 75

● x 2

Average time:
18-24 seconds



CONTROL FREAKS
controlfreaksusa.com



TIGHT (for training) Illustrated by Control Freaks LLC.

Mark out one box at 18'6" x 16'6" square. Set cones to the outside. Measure the rest from these cone bases to ensure proper clearance. Cone bases differ in size.

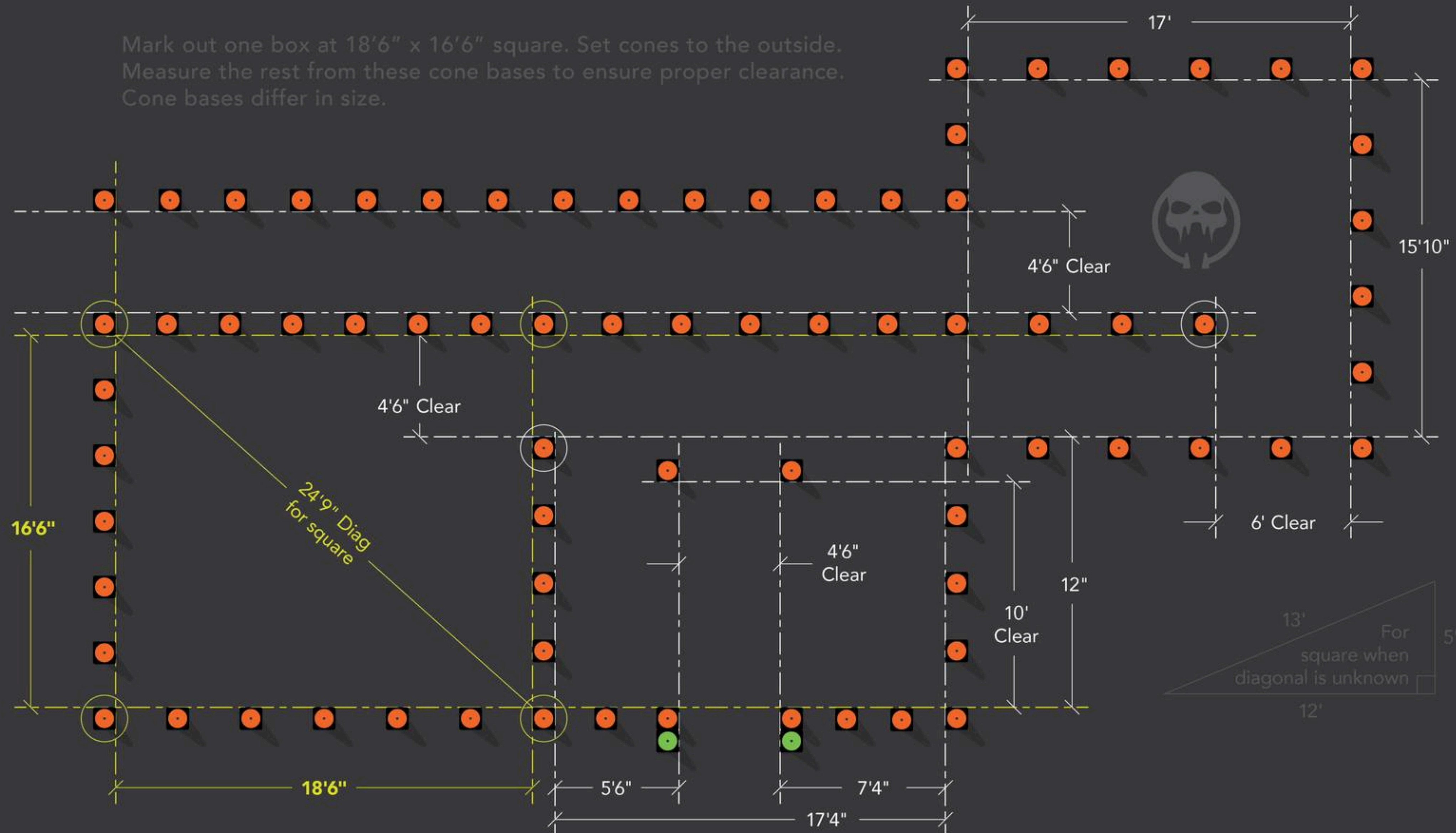

BLEEDING ULCERS

Illustrated by Control Freaks LLC.

- x 46 - 54
- x 2

Average time:
30-40 seconds



CONTROL FREAKS
controlfreaksusa.com

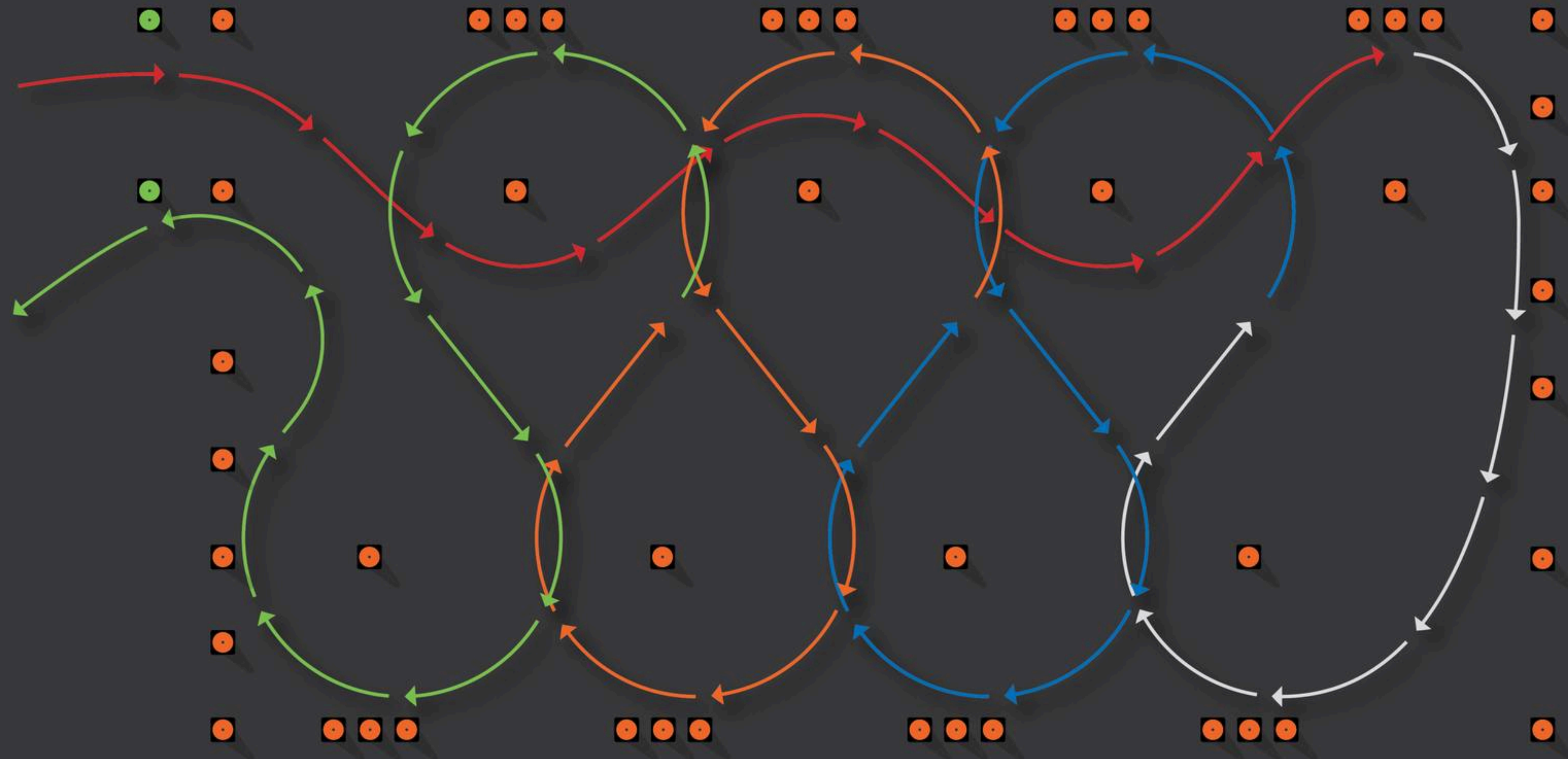

OFFSET WEAVE

Illustrated by Control Freaks LLC.

● x 7
● x 7

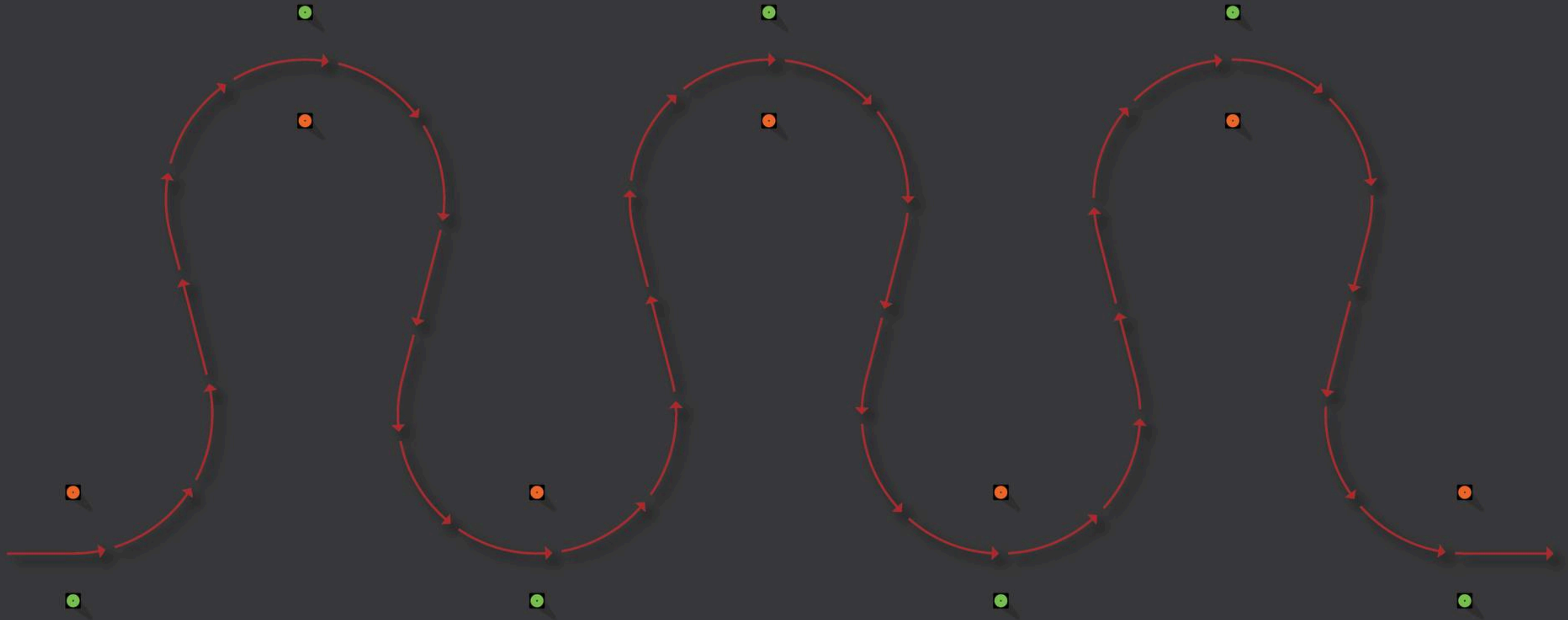

INTERSECTION

Illustrated by Control Freaks LLC.

● x 36 - 64

● x 4

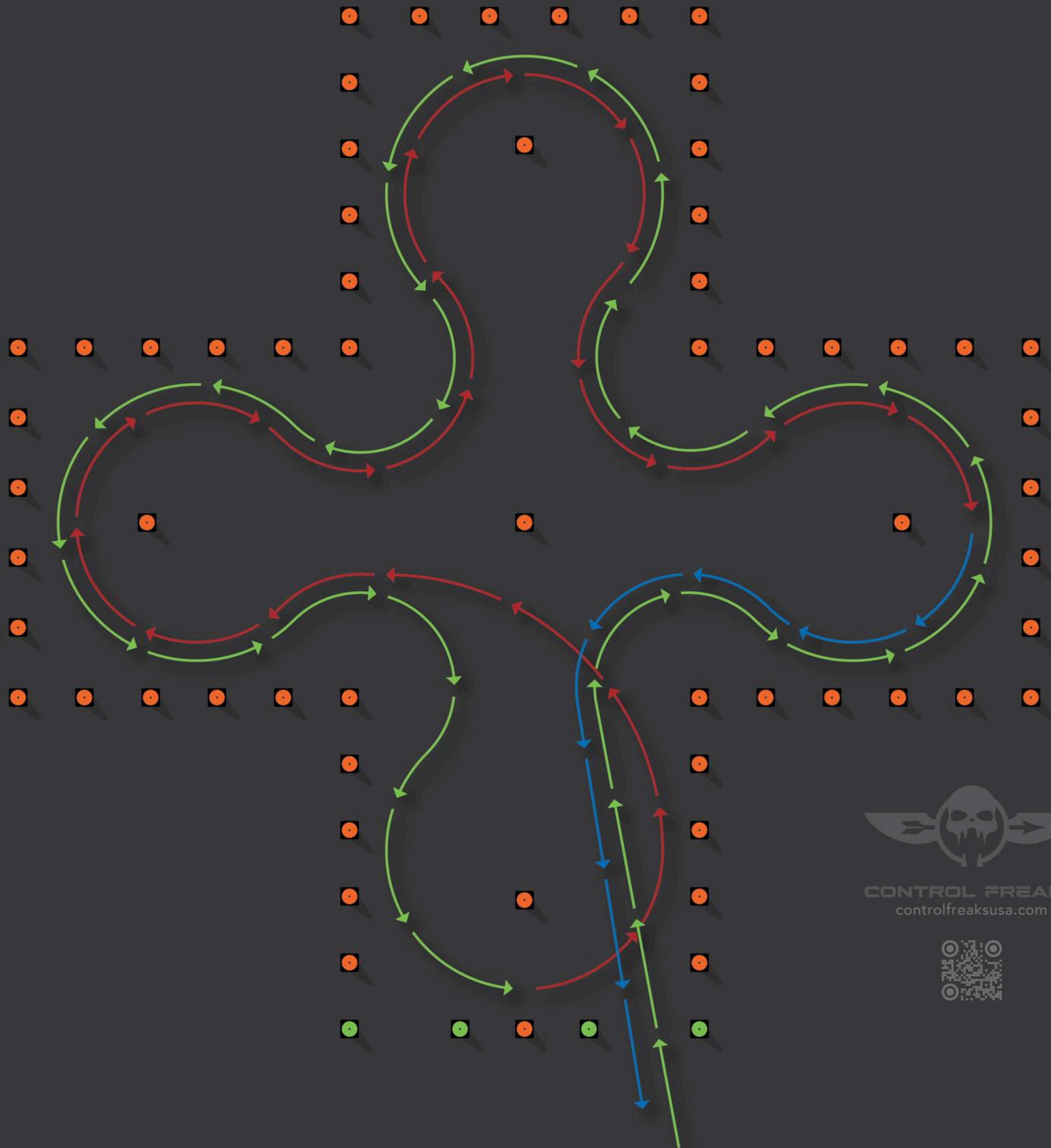

CONTROL FREAKS
controlfreaksusa.com



FIGURE EIGHT

Illustrated by Control Freaks LLC.

- x 24 - 48
- x 4



CONTROL FREAKS
controlfreaksusa.com

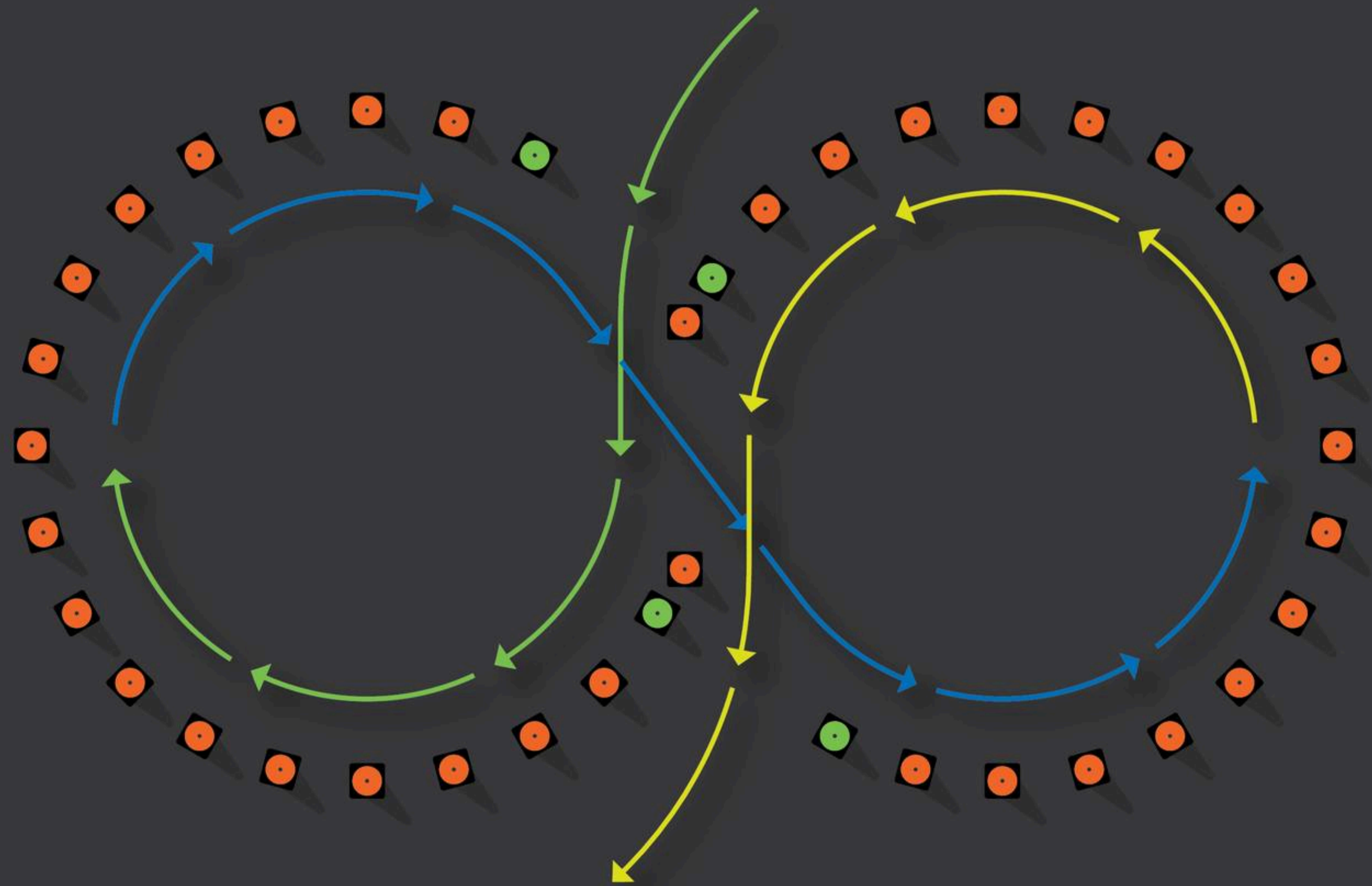

KEYHOLE

● x 18 - 24

● x 2

Illustrated by Control Freaks LLC.



CONTROL FREAKS

controlfreaksusa.com

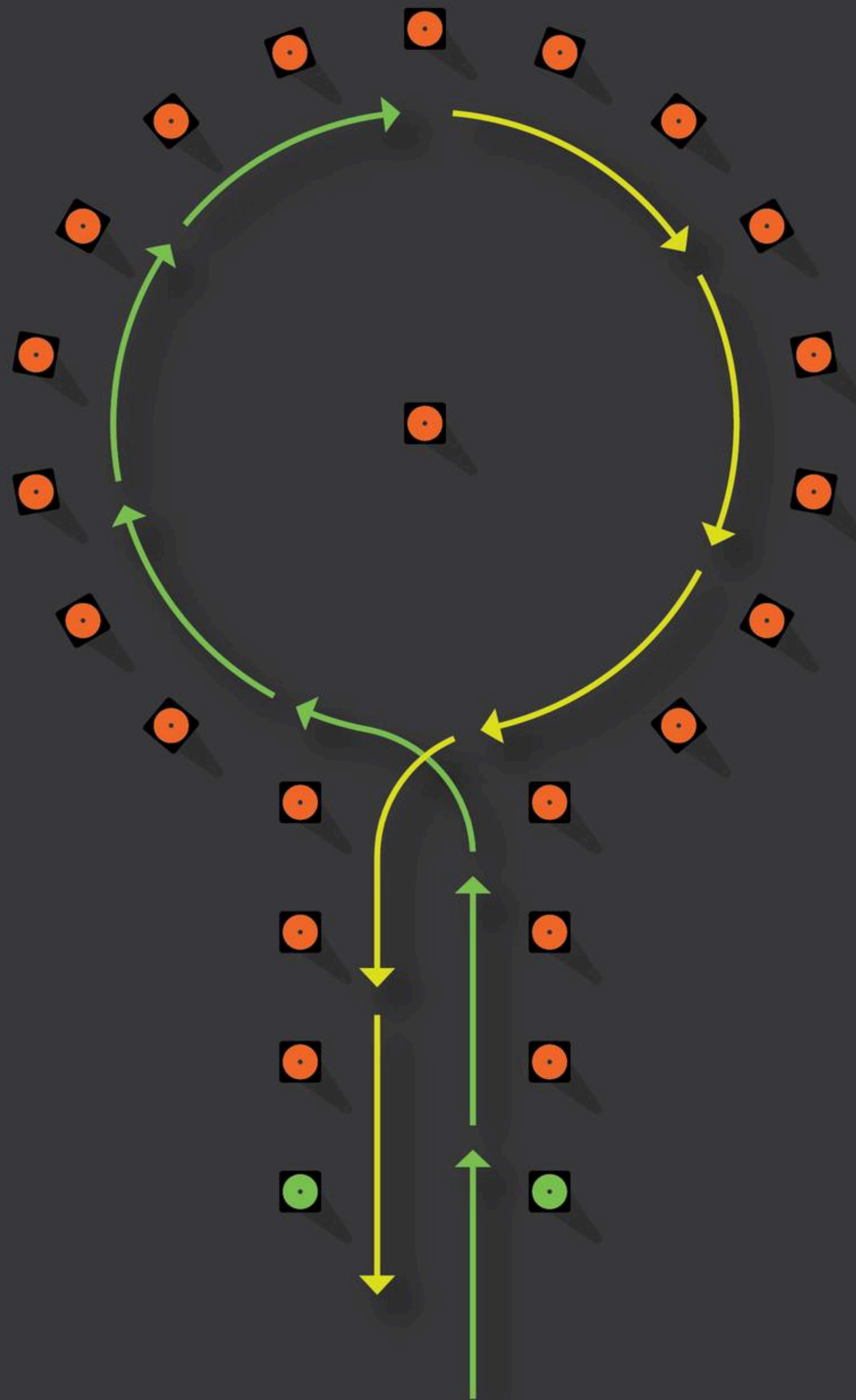



90° Pull-Out

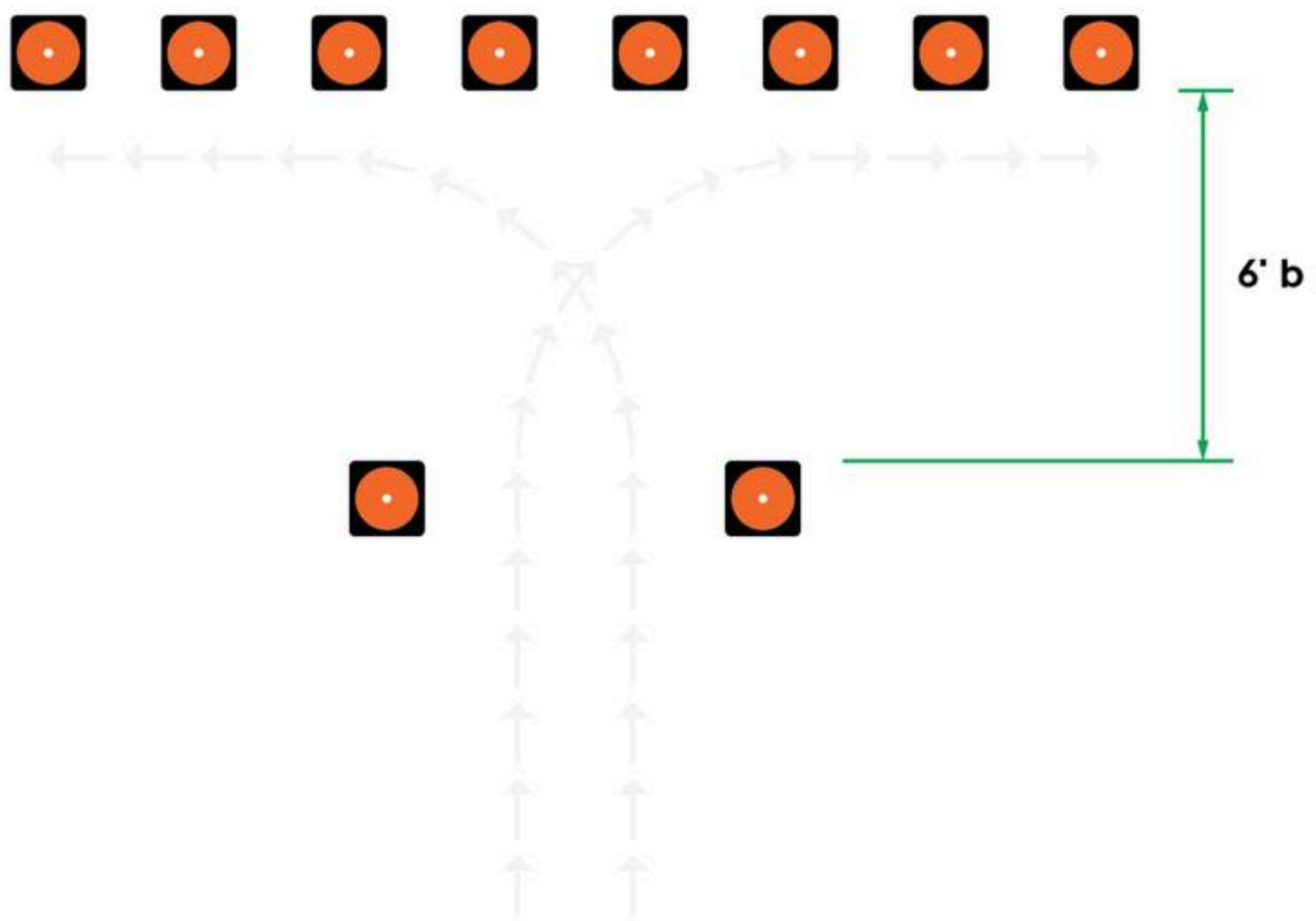

Tall Cone



Tall Gate



Low Cone



Low Gate



Tennis Ball Half



NOTES

X' c = center of cones

X' b = between the cones

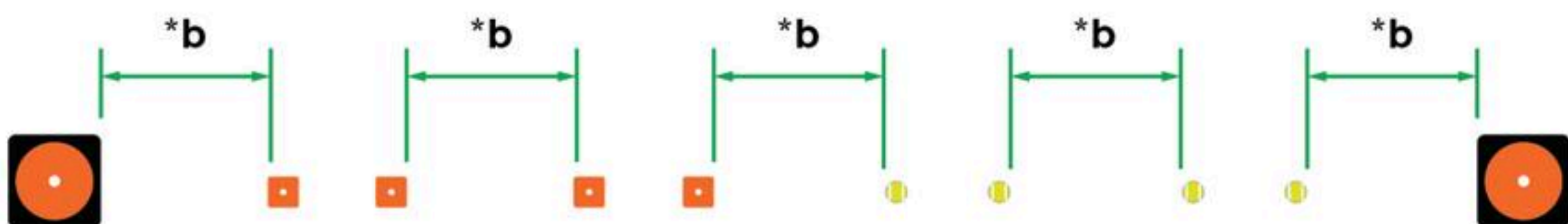

Layouts are not to scale. They are for illustrative purposes only. Use the listed measurements for set-up.



90° Pull-Out

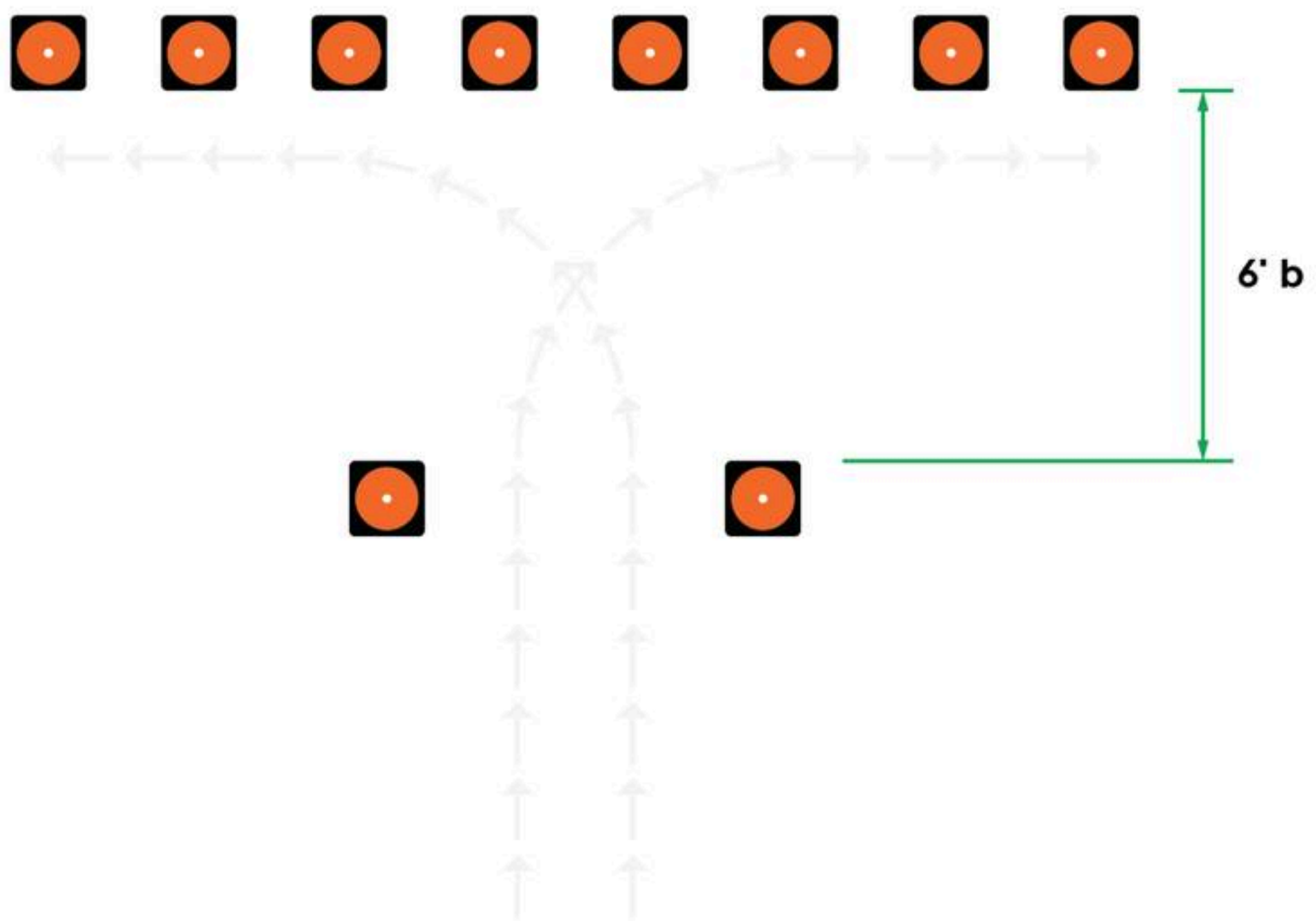

Tall Cone



Tall Gate



Low Cone



Low Gate



Tennis Ball Half



NOTES

X' c = center of cones

X' b = between the cones

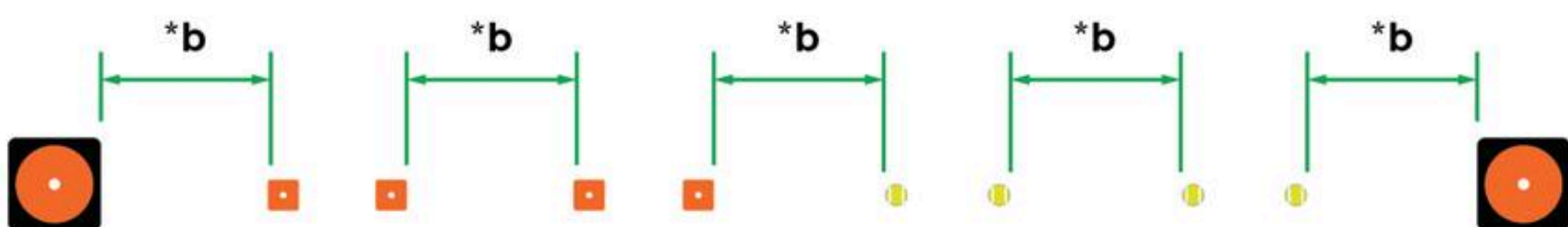

Layouts are not to scale. They are for illustrative purposes only. Use the listed measurements for set-up.

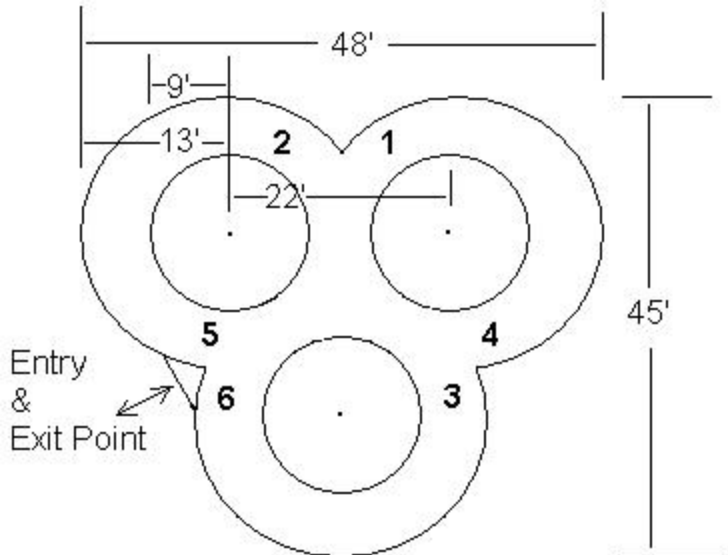

First draw a triangle with 22' sides, Next draw 3 circles with radius of 9' at each apex. Complete the outer circles with 13' radii. Finally label each circle and the entry/exit point.

SLOW CONE WEAVE

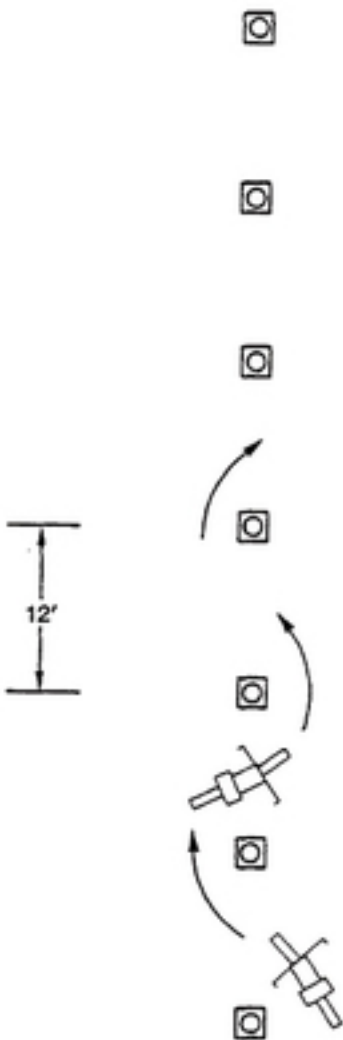

SLOW CONE WEAVE

